



How Do Data Governance & Data Architecture Support Each Other?

Donna Burbank
Global Data Strategy, Ltd.

May 25, 2023



Donna Burbank



Donna is a recognised industry expert in data management with over 25 years of experience in data strategy, data governance, data modeling, metadata management, and enterprise architecture. Her background is multi-faceted across consulting, product development, product management, brand strategy, marketing, and business leadership.

She is currently the Managing Director at Global Data Strategy, Ltd., an international data management consulting company that specializes in the alignment of business drivers with data-centric technology.

In past roles, she has served in key brand strategy and product management roles at CA Technologies and Embarcadero Technologies for several of the leading data management products in the market.

As an active contributor to the data management community, she is a long time DAMA International member, contributor to the DMBOK 2.0, Past President and Advisor to the DAMA Rocky Mountain chapter, and was awarded the Excellence in Data Management Award from DAMA International.

She has worked with dozens of Fortune 500 companies worldwide in the Americas, Europe, Asia, and Africa and speaks regularly at industry conferences. She has co-authored several books and is a regular contributor to industry publications. She can be reached at donna.burbank@globaldatastrategy.com
Donna is based in Boulder, Colorado, US.

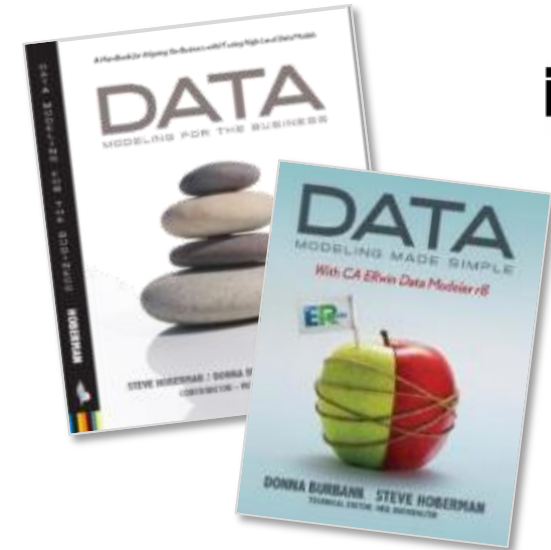

DATAVERSITY Data Architecture Strategies

This Year's Lineup

- **January** Emerging Trends in Data Architecture – What's the Next Big Thing?
- **February** Building a Data Strategy - Practical Steps for Aligning with Business Goals
- **March** Data Mesh or Data Mess? Separating the Reality from the Hype
- **April** Master Data Management - Aligning Data, Process, and Governance
- **May** How do Data Governance & Data Architecture Support Each Other?
- **June** Why You Need Data Management – Getting Executive Buy-In
- **July** Artificial Intelligence and Machine Learning – Building the Right Architectural Foundation
- **August** Data Quality Best Practices (with Nigel Turner)
- **September** Best Practices in Metadata Management
- **October** Designing Data for Business Intelligence & Analytics – Where the Star Schema Fits in a Modern Data Architecture
- **December** Enterprise Architecture vs. Data Architecture



What We'll Cover Today

- The definition of Data Governance can vary depending on the audience.
 - To many, Data Governance consists of committees and stewardship roles.
 - To others, it focuses on technical Data Management and controls.
- Holistic Data Governance combines both aspects, and a robust Data Architecture can be the “glue” that binds business and IT governance together.
- This webinar will provide practical tips aligning Data Architecture and Data Governance for business and IT success.

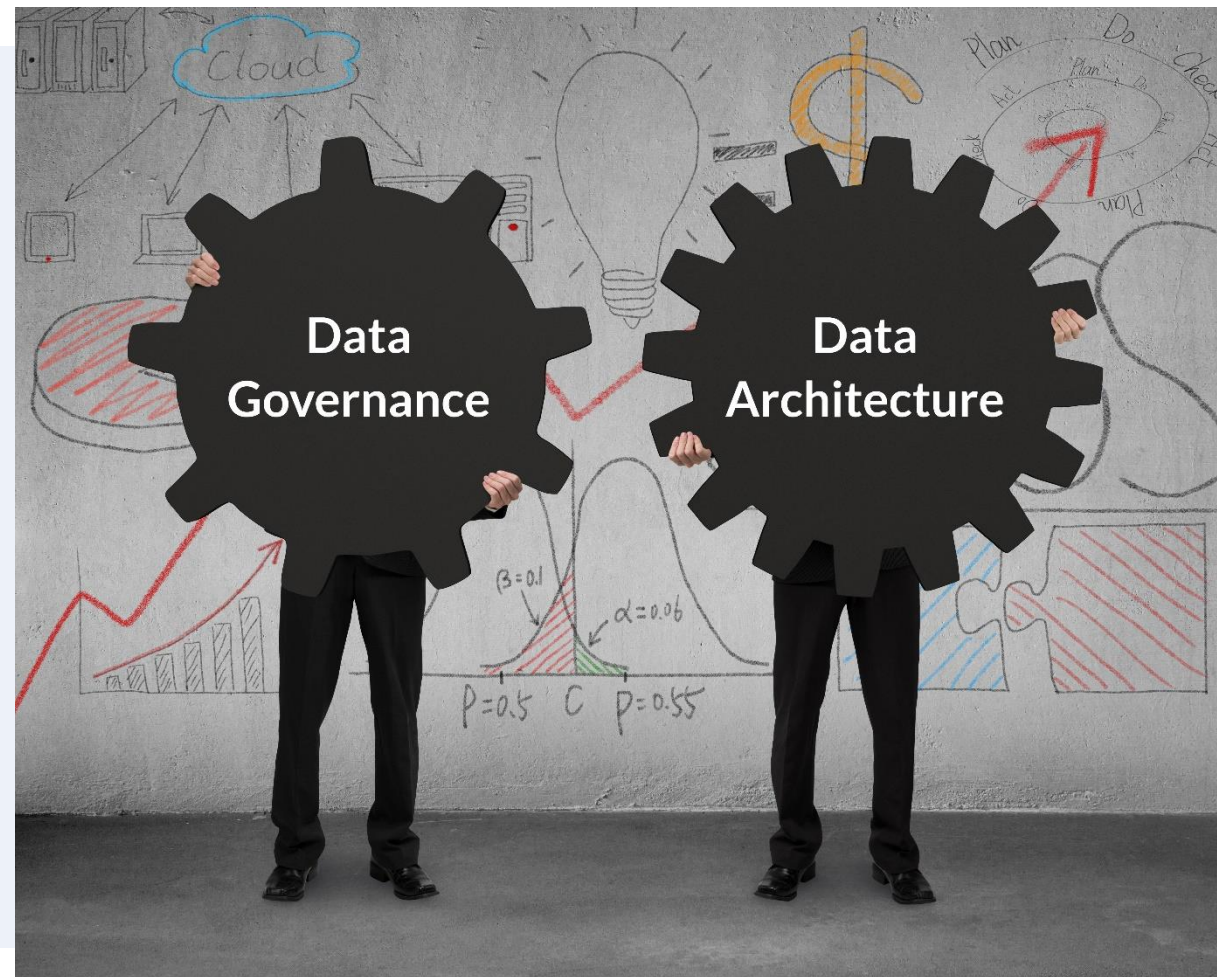

The Importance of Data Governance & Data Architecture

Data Governance & Data Architecture are critical in supporting the data-driven business.

According to a recent survey of organizations globally:

- **88%** have a current **data governance** initiative in place or are planning one in the near future
- **35%** identified **improved collaboration** through using a **defined data architecture**



Data Governance & Architecture improve collaboration and increase data accountability

Definitions – Data Governance vs. Data Architecture

DAMA DMBOK Definitions

Data Governance

- “Data Governance is the exercise of **authority, control and shared decision-making** (planning, monitoring and enforcement) over the management of data assets.”

Data Architecture

- “Data Architecture is fundamental to data management. Because most organizations have more data than individual people can comprehend, it is necessary to **represent organizational data at different levels of abstraction so that it can be understood** and management can make decisions about it.
- ... Data Architecture **artifacts include specifications used to describe existing state, define data requirements, guide data integration, and control data assets as put forth in data strategy.** “

Data Architecture can in many ways be considered the Technical Side of Data Governance

Data Architecture & Governance - Part of a Wider Data Strategy

A Successful Data Strategy links Business Goals with Technology Solutions

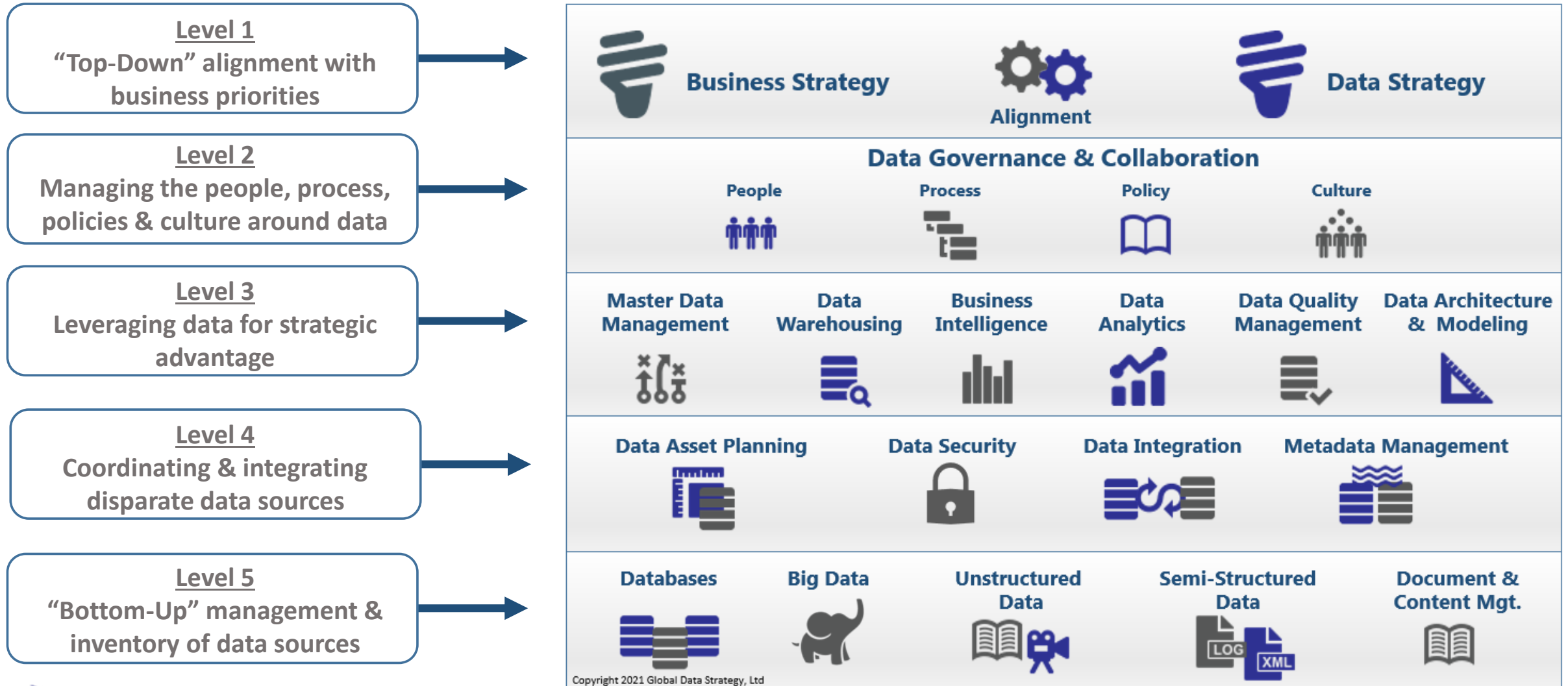

Copyright 2021 Global Data Strategy, Ltd

Applying a Structured Data Governance Framework



Building the Data Governance Framework

Vision & Strategy	Organization & People	Processes & Workflows	Data Management & Measures	Culture & Communications	Tools & Technology
Is there a clear understanding of the strategic goals of your organization & the need for enterprise data governance?	Who are the key data stakeholders within and outside your organization?	Do business process design and operations management take data needs into account?	Has key data been identified, defined and analyzed?	Has the importance of data been communicated across the organization? Is there a data communications plan?	Is there a coherent data architecture in place to define and guide how data is captured, processed, stored and used?
How does your organization rely on data – now and in the future?	Who are the primary data producers, consumers & modifiers?	Are there any specific data management / improvement processes in place?	Have data models been built – conceptual / logical / physical?	Is the value of good data management understood and championed by senior managers?	What primary IT systems and platforms are used to store and process key data?
What impact are data problems currently having on your organization?	Are individuals formally accountable for data ownership?	Are there issue and workflow management processes to address data problems?	Has the relationship between business processes and data been mapped?	Do all employees and third parties receive data awareness and improvement education and training?	Do design gateways exist to ensure data needs are taken into account in new & modified platforms?
Do you have a data governance policy?	Are employees trained in good data management practices?	Has there been any analysis of the efficiency and effectiveness of how data is managed within operational business processes?	Are data shortcomings known, measured & recorded?	Are there communication channels for communicating best practice in data management?	What specialist data management tools are currently in use?
What are the overall expected benefits of better data governance?	Are there any channels through which data shortcomings can be highlighted and investigated?	How does the business and IT interact to manage data improvement?	Are there are formal standards & rules specifying how data should be managed and improved?	Are there internal success stories that could be used to promote better data management across the organization?	What metadata is captured and stored?



Organization & People: Data Governance Roles - Examples



While there is no “one size fits all” approach to governance roles, the following are some examples:

Executive Sponsor



- Promotes Data Driven Culture
- Champions Best Practices
- Advocate with ELT and Board
- Escalation Point for Key Issues

Business Data Owner



- Represents the data needs for a particular functional area
- Defines key KPIs & data elements
- Defines key business rules
- Sets Data Quality Metrics & Thresholds

Business Data Steward



- Responsible for the day-to-day management and quality of data
- Subject Matter Expert (SME) for a given business domain
- Aligns with the Data Owner to support business rules and to align with key KPIs

Technical Data Steward



- Digital/IT expert for a given business unit
- Subject matter expert for a given system and its usage
- Aligns with Business Data Stewards to ensure technical needs are met



Data Governance Lead*

- Acts as a cross-functional lead for the data governance effort, working with both business and IT roles
- Chair of the Data Governance Steering Committee



Enterprise Data Architect*

- Oversees the holistic data architecture for the organization, including data models, data standards, data integration, etc.
- Works with both business and technical stakeholders to ensure that systems implementations align with key business rules & needs

* Typically a full-time role

The Diversity of Data Governance

Something for everyone...to love...or hate...or somewhere in between

- The Scope of Data Governance is diverse:
 - From the “touchy feely” people side
 - To the “detailed nerdy” technical side
- i.e. There is something for everyone....And everyone is likely to hate some part... 😊

I love working with people!



I love creating databases!

A Wide Range of Roles are Involved

Data Architecture - Technical

CIO	Data Architect Business Analyst Enterprise Architect Data Modeler	Data Architect Solution Architect	Data Architect Data Modeler Data Engineer	Data Engineer Data Integrator ETL Developer	Data Engineer DBA	Infrastructure Engineer
Data-centric Business Vision & Design	Business Requirements	Data Landscape Vision & Design	Database / Data Store Vision & Design	Data Landscape Execution	Database / Data Store Execution	Platform Infrastructure
<ul style="list-style-type: none"> • Business Model Design • P&L Responsibility • Etc. 	<ul style="list-style-type: none"> • Business Capability Models • Business Process Models • Design Thinking • Conceptual Data Model 	<ul style="list-style-type: none"> • System Architecture Diagrams • Data Flow Diagrams • New Technology Exploration 	<ul style="list-style-type: none"> • Data models • Data store selection • Glossary • Semantic layer • Etc. 	<ul style="list-style-type: none"> • Data platform configuration • Data integration • Performance & tuning • Etc. 	<ul style="list-style-type: none"> • Database creation • Data store implementation • Performance & tuning • Etc. 	<ul style="list-style-type: none"> • Server & hardware setup • Cloud platform configuration • Backup and Recovery • Etc.
CEO, CMO, CFO, etc. CDO	Data Owners Data Governance Lead		Data Stewards Data Governance Lead			

Data Governance - Business



Process & Workflow Includes both Business & Technical

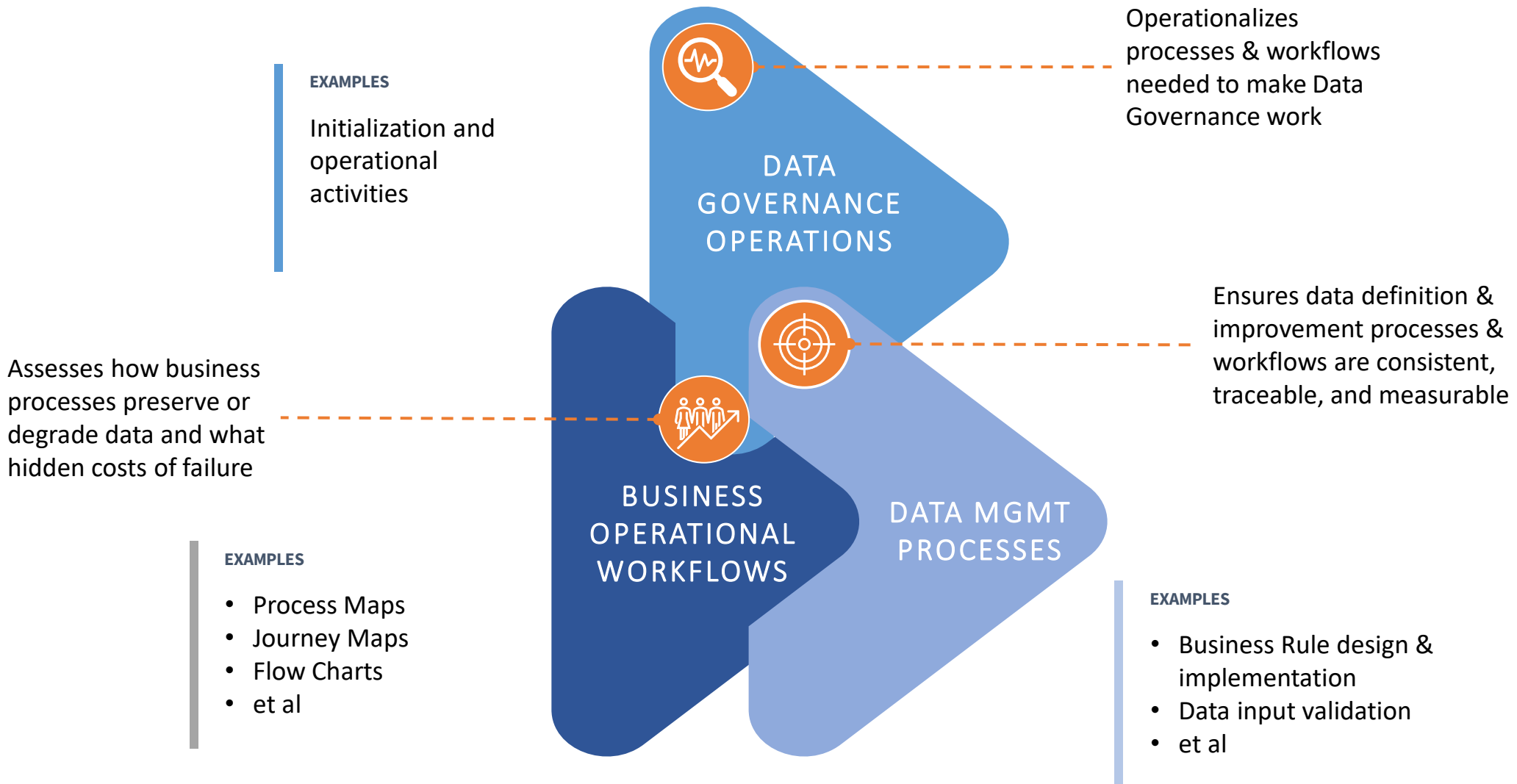

Scope of Business vs. Technical Data Governance Activities

Data Governance is a Team Sport – an Orchestra, not a Solo

Business-centric Governance	Shared	Technical-centric Governance
Data-centric business goals and vision	Data-centric business rules & definitions	Data architecture strategy & roadmap
Prioritization of data initiatives	Conceptual Data Models	Data-centric tool standards
ROI and Success Criteria	Logical Data Models	Physical Data Models
Business Glossary	Data Catalog / Data Dictionary	Physical Data Standards (naming conventions, data types, etc.)
	Data lifecycle & retention rules	Platform change management
Etc.	Etc.	Etc.

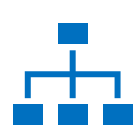

Data Mgt & Measures: The Critical Role of Data Architecture



A high-level data architecture provides the roadmap for data governance & associated activities.

What data do we prioritize? Where is this data used? Where is this data stored? What rules apply to this data? What is the quality of the data?

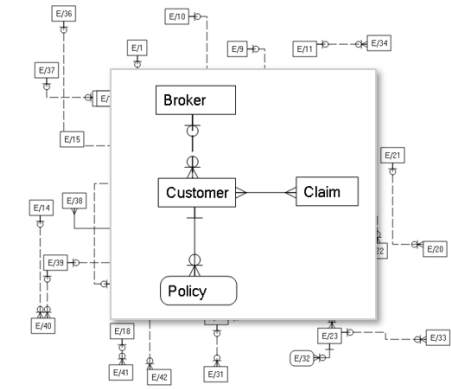

Business data model

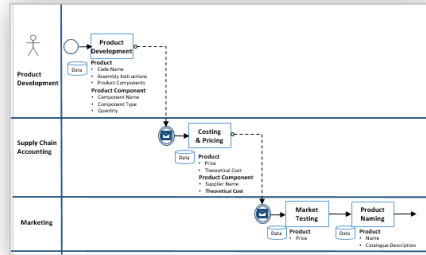

Business process models

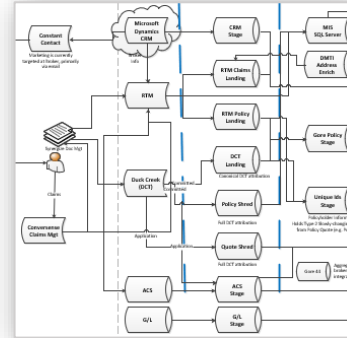

Data architecture diagram



Business rules & policy

Data quality dashboard

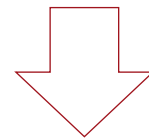

This architecture provides a guide for small, targeted projects for business value to add additional detail.

What data best supports our Brokers?



What data best supports our Customers?



What data can we use to best Price our Policies?



What external data can we use for business advantage?



Metadata Makes Data Governance Actionable

- Metadata can help take the business rules & definitions defined in policies and make them actionable in physical systems, maintaining a lineage & audit trail.

Policies & Procedures



Technical Implementation

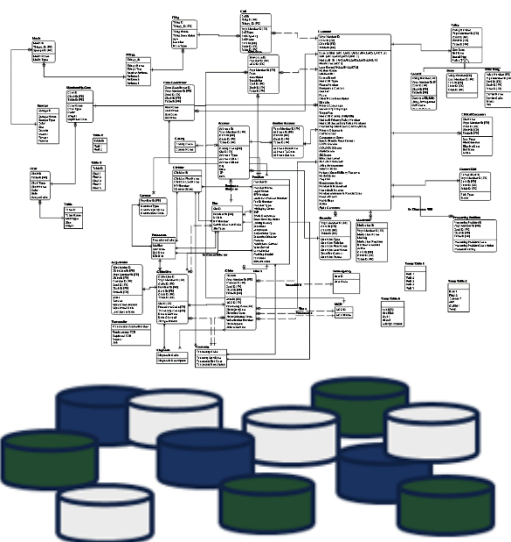

Audit & Lineage

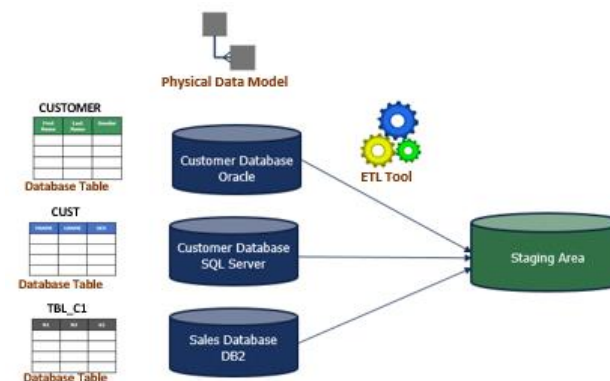

Metadata is the “Who, What, Where, Why, When & How” of Data

Who	What	Where	Why	When	How
Who created this data?	What is the business definition of this data element?	Where is this data stored?	Why are we storing this data?	When was this data created?	How is this data formatted? (character, numeric, etc.)
Who is the Steward of this data?	What are the business rules for this data?	Where did this data come from?	What is its usage & purpose?	When was this data last updated?	How many databases or data sources store this data?
Who is using this data?	What is the security level or privacy level of this data?	Where is this data used & shared?	What are the business drivers for using this data?	How long should it be stored?	
Who “owns” this data?	What is the abbreviation or acronym for this data element?	Where is the backup for this data?		When does it need to be purged/deleted?	
Who is regulating or auditing this data?	What are the technical naming standards for database implementation?	Are there regional privacy or security policies that regulate this data?			

Data Models are Great Tools to Span Business & Technical Governance

Audience

Purpose

Business Stakeholders
Data Architects

Organization & Scoping of main
business domain areas

Business Stakeholders
Data Architects

Communication & Definition of
Business Concepts & Rules

Data Architects
Business Analysts

Clarification & Detail
of Business Rules &
Data Structures

DBAs
Developers

Technical
Implementation on
a Physical Database

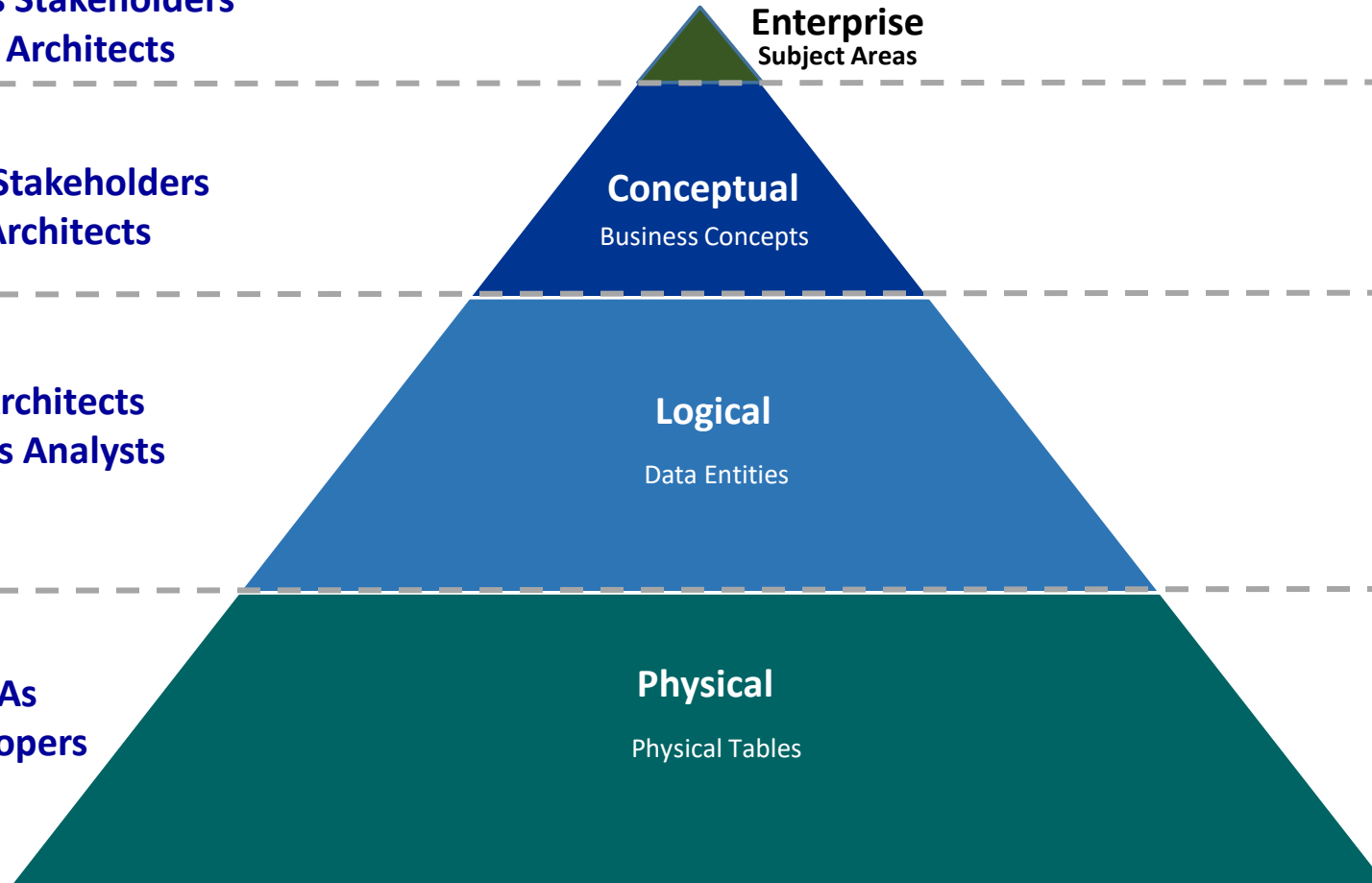

Business Data Model (Conceptual)

- Communication & definition of core data concepts & their definitions

- A business data model provides core **definitions** of key data objects.

- It also shows key **relationships** between data objects.

- Even a simple diagram as the one on the right can tell a powerful **“story”**

.... And uncover key **business issues and opportunities.**

- How do we define a “customer” vs. a “client”

- Is our employee relationship different for each?

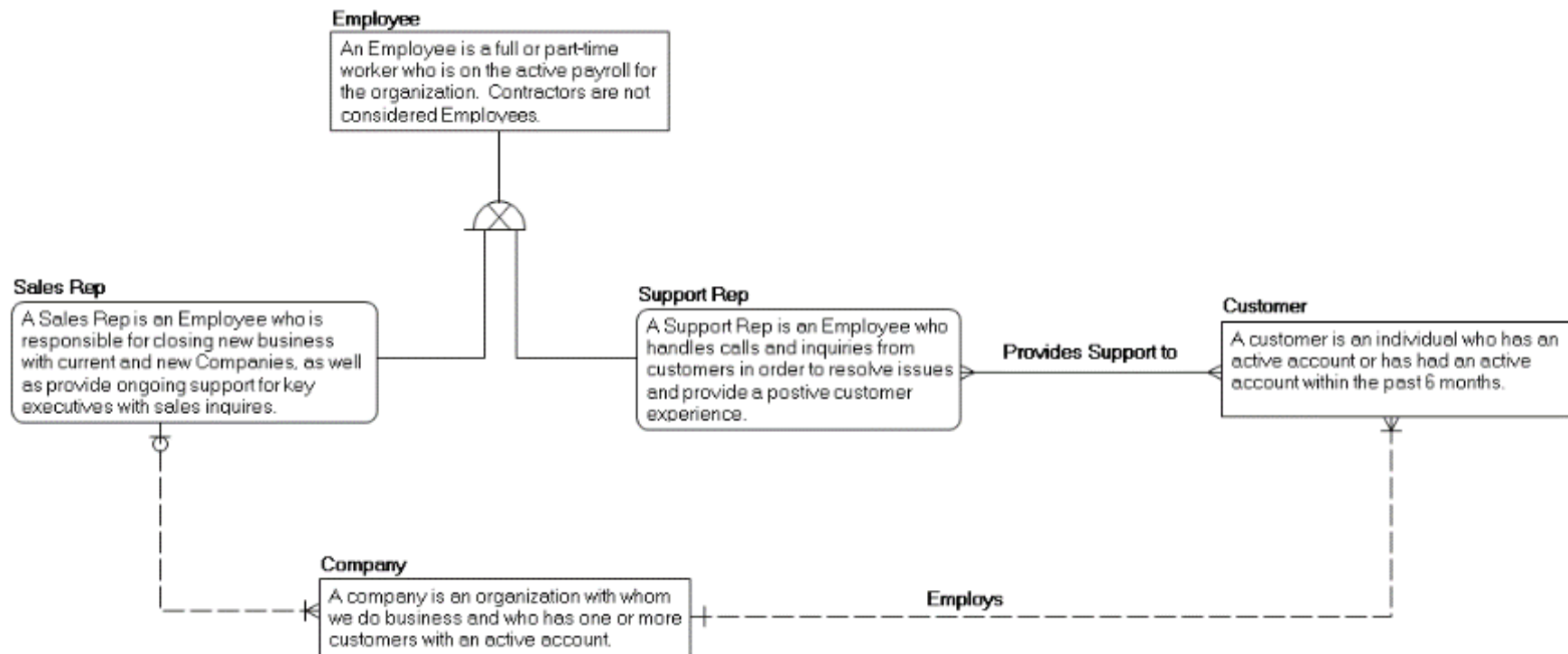

Logical Data Model

- A logical data model
 - Defines detailed business rules
 - Includes attributes, data types, nullability, etc.
 - Defines data structures, but not physical tables (e.g. hierarchies)
 - And uncovers key business issues and opportunities.
- Can a customer have more than one address?
- Is Fax number still a required field?
- What is a fax number???....

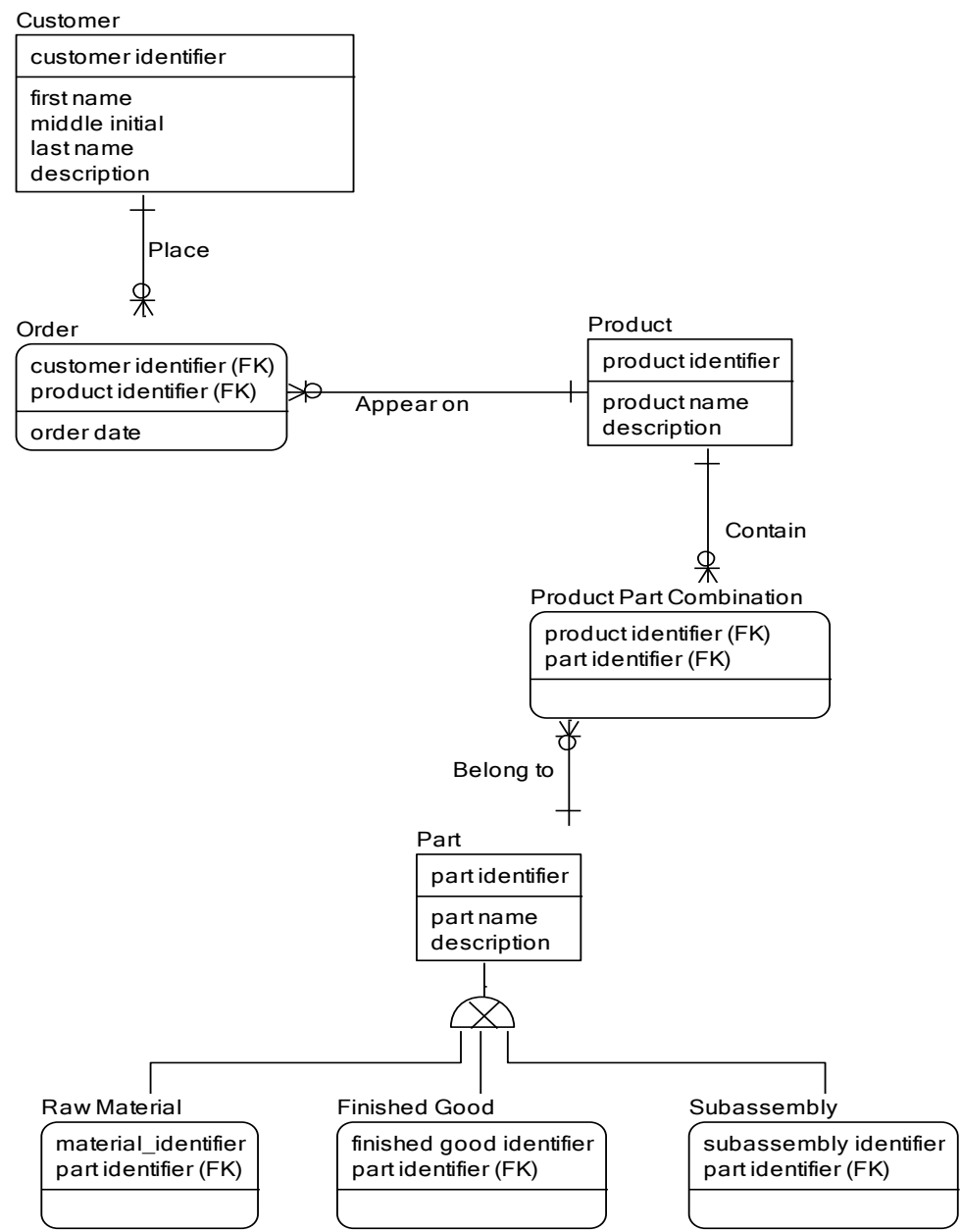

Physical Data Model

- A physical data model
 - Defines data structures to store data on a physical platform (e.g. RDMBS, Document data store, etc.)
 - Optimizes for performance, query, etc.
- ... And ensures that data is stored in a fit for purpose manner. e.g. How can I:
 - Store data to reduce redundancy and increase data quality?
 - Optimize data storage to “slice and dice” for self-service analytics?
 - Optimize data storage for speed of query?

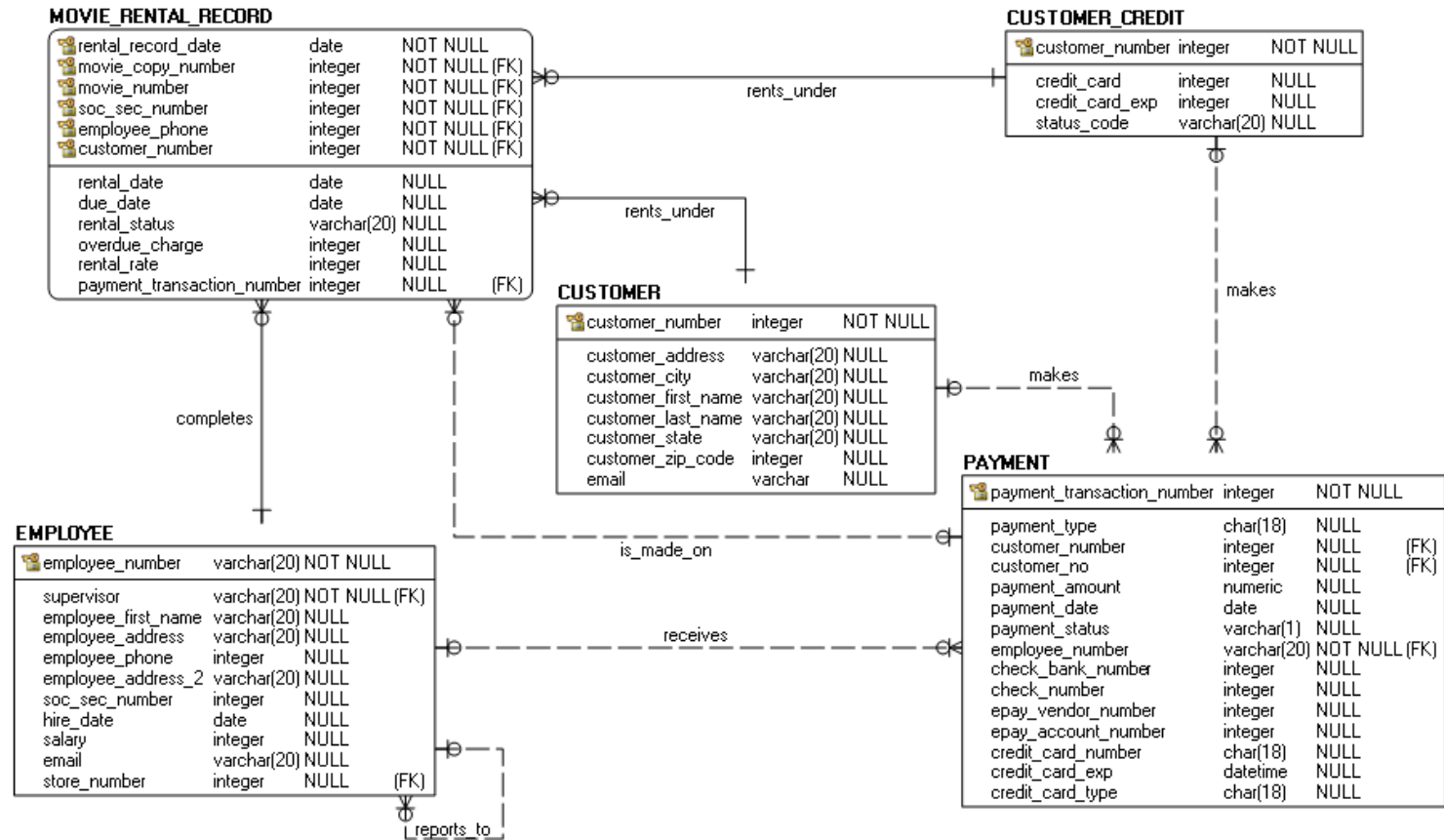



Tools & Platforms

Functionality	Tech Importance	Business Need
Data Governance Organization	13	29
Processes & Workflow	16	20
Issue Logging & Management	16	22
Business Glossary	39	43
Metadata Management & Inventory	37	43
Data Lineage & Mapping	21	23
Data Reuse & Trusted Data Sets	20	22
Data Lifecycle Management	17	24
Data Quality	19	22
Security & Privacy	18	25
Communication & Collaboration		

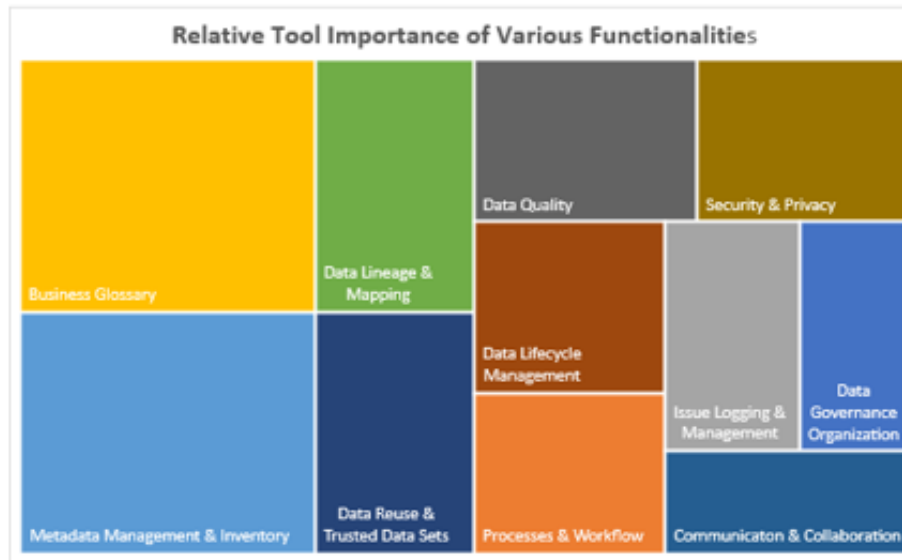

- There is no “one size fits all” data governance or data architecture tool.
- Pick the solutions that match your uses cases & audiences.
- Not everything needs a tool (e.g. business process change, policies, culture change....)
- Typically, a variety of tools are used:
 - Data Catalog
 - Data Modeling Tool
 - Workflow Automation
 - Enterprise Architecture Tools
 - Master Data Management Tools
 - Data Quality Tools
 - MS Word , Excel, SharePoint
 - Etc...

Data Governance through Data Architecture

Using Data to Build Customer Loyalty & Increase Sales

- A major Retail Vendor wanted to become a data-driven company
 - Enhancing the customer experience by **mapping the Customer Journey to the Data Lifecycle**
 - Using **IoT product data to improve product design & customer service**
 - **Optimizing product supply chain & delivery**
- Developing a Tactical Data Strategy determined that
 - **Master Data Management** was needed to manage customer contact data throughout the Customer Journey
 - **Data Governance** was required to manage data across organizational siloes: product development, marketing, sales, etc.
 - **Data Architecture** was needed to understand the data ecosystem: data flow diagrams, data models, process models, etc.

How is email address used across the business functions?

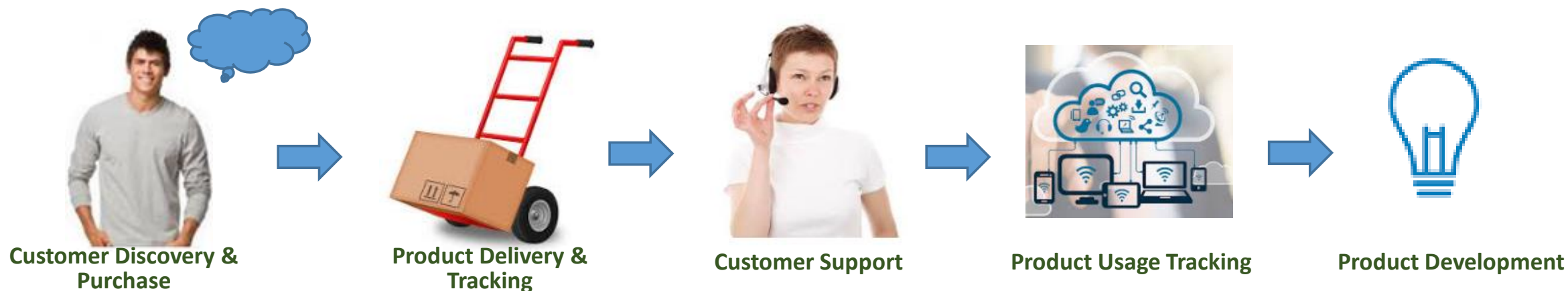

- Data Governance has **both business and technical aspects**.
- **Data Architecture and Data Governance should work together** in the successful data-driven organization.
- “It takes a village” of **roles across business and IT** to be successful.
- **Process and workflow optimization** is important across both business and IT.
- **Tools are an enabler, but not the total solution.**



DATAVERSITY Data Architecture Strategies

Join Us Next Month

- **January** Emerging Trends in Data Architecture – What’s the Next Big Thing?
- **February** Building a Data Strategy - Practical Steps for Aligning with Business Goals
- **March** Data Mesh or Data Mess? Separating the Reality from the Hype
- **April** Master Data Management - Aligning Data, Process, and Governance
- **May** How do Data Governance & Data Architecture Support Each Other?
- **June** Why You Need Data Management – Getting Executive Buy-In
- **July** Artificial Intelligence and Machine Learning – Building the Right Architectural Foundation
- **August** Data Quality Best Practices (with Nigel Turner)
- **September** Best Practices in Metadata Management
- **October** Designing Data for Business Intelligence & Analytics – Where the Star Schema Fits in a Modern Data Architecture
- **December** Enterprise Architecture vs. Data Architecture



Who We Are: Business-Focused Data Strategy

Maximize the Organizational Value of Your Data Investment



In today's business environment, showing **rapid time to value** for any technical investment is critical.

But technology and data can be complex. At Global Data Strategy, **we help demystify technical complexity** to help you:

- Demonstrate the ROI and **business value of data** to your management
- Build a data strategy **at your pace to match your unique culture** and organizational style.
- Create an **actionable roadmap for “quick wins”**, which building towards a long-term scalable architecture.

Global Data Strategy's shares experience from some of the largest international organizations scaled to the pace of your unique team.

Global Data Strategy has worked with organizations globally in the following industries:

Finance · Retail · Social Services · Health Care · Education · Manufacturing
· Government · Public Utilities · Construction · Media & Entertainment ·
Insurance and more



Thoughts? Ideas?
Questions?